

Air Excellent distribution box DB808 125-200 8 connections

Article number: 188950

Product introduction

The Air Excellent DB824 is designed to radially distribute air from a ventilation unit, minimizing system pressure drop, fan energy use, and sound levels. It is compatible with Aerfoam insulated ducts and features 8 Air Excellent AE34C duct connections. With DBOX adaptors, it can connect to any duct diameter within the Air Excellent range. It offers flexible placement options on either the ceiling or wall and can be connected vertically or horizontally.

- Includes stepped adaptor, 8 internal air restrictor rings, and 4 covers for unused connections
- Multiple openings for flexible configurations and easy installation/inspection access
- Made of durable, rust-free, lightweight plastic (PP) ensuring ease of handling and installation
- Airtight mechanical connections to minimize pressure loss, fan energy consumption, and sound levels



Product dimensions

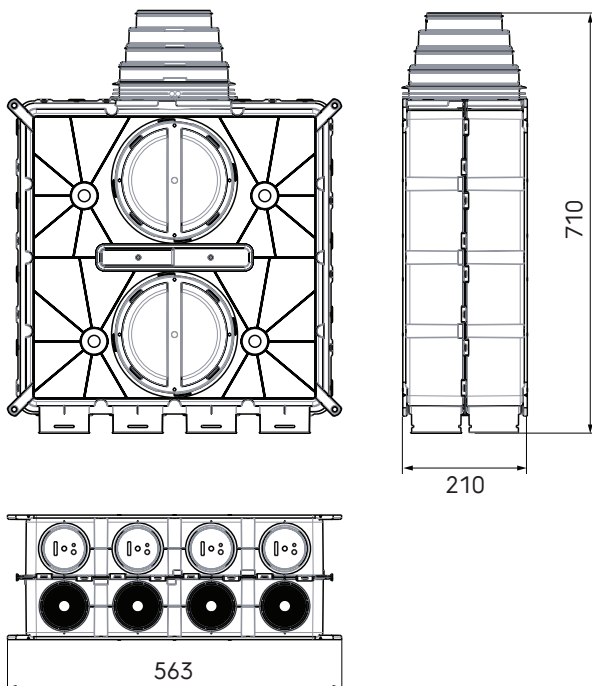

Air Excellent distribution box DB808 125-200 8 connections

Article number: 188950

Technical specifications

Specifications	
Technical	
Colour	Grey
Material	PP
Anti static	<input checked="" type="checkbox"/>
Antimicrobial	<input checked="" type="checkbox"/>
Performance	
Temperature resistance (min.)	-20 °C
Temperature resistance (max.)	60 °C
Reaction to fire: Euro class	E
Dimensions	
Length gross	710 mm
Width	563 mm
Height	210 mm
Net weight	2.731 kg

Air Excellent distribution box DB808 125-200 8 connections

Article number: 188950

Technical details

Pressure Loss Dbox	
Qv (Volume) [m³/h]	Δp (Pressure Loss) [Pa]
50	0,2
100	0,8
150	1,6
200	2,7
250	4,0
300	5,7
350	7,6
400	9,8
450	12,3
500	15,1
550	18,2
600	21,5
650	25,2
700	29,1
750	33,3
800	37,8

Figures are based on measurements by the TÜV SÜD.